

**TASCAM**  
TEAC PROFESSIONAL

D01105620B

# US-800

**USB 2.0 Audio/MIDI Interface**

**OWNER'S MANUAL**

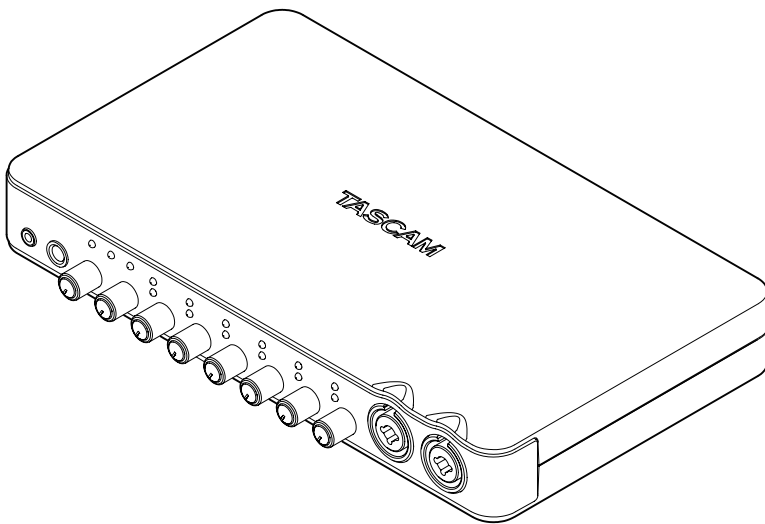

# IMPORTANT SAFETY INFORMATION



**CAUTION**  
RISK OF ELECTRIC SHOCK  
DO NOT OPEN



CAUTION: TO REDUCE THE RISK OF ELECTRIC SHOCK, DO NOT REMOVE COVER (OR BACK). NO USER-SERVICEABLE PARTS INSIDE. REFER SERVICING TO QUALIFIED SERVICE PERSONNEL.



The lightning flash with arrowhead symbol, within equilateral triangle, is intended to alert the user to the presence of uninsulated "dangerous voltage" within the product's enclosure that may be of sufficient magnitude to constitute a risk of electric shock to persons.



The exclamation point within an equilateral triangle is intended to alert the user to the presence of important operating and maintenance (servicing) instructions in the literature accompanying the appliance.

FOR U.S.A.  
TO THE USER

This equipment has been tested and found to comply with the limits for a Class B digital device, pursuant to Part 15 of the FCC Rules. These limits are designed to provide reasonable protection against harmful interference in a residential installation. This equipment generates, uses, and can radiate radio frequency energy and, if not installed and used in accordance with the instructions, may cause harmful interference to radio communications. However, there is no guarantee that interference will not occur in a particular installation. If this equipment does cause harmful interference to radio or television reception, which can be determined by turning the equipment off and on, the user is encouraged to try to correct the interference by one or more of the following measures.

- Reorient or relocate the receiving antenna.
- Increase the separation between the equipment and receiver.
- Connect the equipment into an outlet on a circuit different from that to which the receiver is connected.
- Consult the dealer or an experienced radio/TV technician for help.

### CAUTION

Changes or modifications to this equipment not expressly approved by TEAC CORPORATION for compliance could void the user's authority to operate this equipment.

**WARNING: TO PREVENT FIRE  
OR SHOCK HAZARD, DO NOT  
EXPOSE THIS  
APPLIANCE TO RAIN OR  
MOISTURE.**

### Declaration of Conformity

Model Number: US-800  
Trade Name: TASCAM  
Responsible party: TEAC AMERICA, INC.  
Address: 7733 Telegraph Road, Monte-  
bello, California, U.S.A.  
Telephone number: 1-323-726-0303

This device complies with Part 15 of the FCC Rules. Operation is subject to the following two conditions: (1) This device may not cause harmful interference, and (2) This device must accept any interference received, including interference that may cause undesired operation.

This appliance has a serial number located on the bottom panel. Please record the model number and serial number and retain them for your records.

Model number \_\_\_\_\_  
Serial number \_\_\_\_\_

# IMPORTANT SAFETY INFORMATION

- 1 Read these instructions.
  - 2 Keep these instructions.
  - 3 Heed all warnings.
  - 4 Follow all instructions.
  - 5 Do not use this apparatus near water.
  - 6 Clean only with dry cloth.
  - 7 Do not block any ventilation openings. Install in accordance with the manufacturer's instructions.
  - 8 Do not install near any heat sources such as radiators, heat registers, stoves, or other apparatus (including amplifiers) that produce heat.
  - 9 Do not defeat the safety purpose of the polarized or grounding-type plug. A polarized plug has two blades with one wider than the other. A grounding type plug has two blades and a third grounding prong. The wide blade or the third prong are provided for your safety. If the provided plug does not fit into your outlet, consult an electrician for replacement of the obsolete outlet.
  - 10 Protect the power cord from being walked on or pinched particularly at plugs, convenience receptacles, and the point where they exit from the apparatus.
  - 11 Only use attachments/accessories specified by the manufacturer.
  - 12 Use only with the cart, stand, tripod, bracket, or table specified by the manufacturer, or sold with the apparatus. When a cart is used, use caution when moving the cart/apparatus combination to avoid injury from tip-over.
- 
- 13 Unplug this apparatus during lightning storms or when unused for long periods of time.
  - 14 Refer all servicing to qualified service personnel. Servicing is required when the apparatus has been damaged in any way, such as power-supply cord or plug is damaged, liquid has been spilled or objects have fallen into the apparatus, the apparatus has been exposed to rain or moisture, does not operate normally, or has been dropped.
    - Do not expose this apparatus to drips or splashes.
    - Do not place any objects filled with liquids, such as vases, on the apparatus.
    - Do not install this apparatus in a confined space such as a book case or similar unit.
    - The apparatus draws nominal non-operating power from the AC outlet with its POWER or STANDBY/ON switch not in the ON position.
    - The apparatus should be located close enough to the AC outlet so that you can easily grasp the power cord plug at any time.
    - The mains plug is used as the disconnect device; the disconnect device shall remain readily operable.
    - If the product uses batteries (including a battery pack or installed batteries), they should not be exposed to sunshine, fire or excessive heat.
    - CAUTION for products that use replaceable lithium batteries: there is danger of explosion if a battery is replaced with an incorrect type of battery. Replace only with the same or equivalent type.
    - Caution should be taken when using earphones or headphones with the product because excessive sound pressure (volume) from earphones or headphones can cause hearing loss.

## 产品有毒有害物质或元素的名称及含量

機種：US-800		有毒有害物质或元素					
	品名	铅 (Pb)	汞 (Hg)	镉 (Cd)	六价铬 (Cr (VI))	多溴联苯 (PBB)	多溴二苯醚 (PBDE)
1	CHASSIS部份	○	○	○	○	○	○
2	PCB Assy部份	×	○	○	○	○	○
3	线材部份	○	○	○	○	○	○
4	附属品部份	×	○	○	○	○	○
5	SEAL部份	○	○	○	○	○	○
6	包装部份	○	○	○	○	○	○

○：表示该有毒有害物质在该部件所有均质材料中的含有量均在 SJ/T11363-2006 标准规定的限量要求以下。

×：表示该有毒有害物质至少在该部件的某一均质材料中的含量超出 SJ/T11363-2006 标准规定的限量要求。

(针对现在代替技术困难的电子部品及合金中的铅)

# Table of Contents

<b>1 – Introduction .....</b>	<b>5</b>	Headphones .....	24
Main features.....	5	Connecting MIDI devices .....	24
Product parts.....	5	<b>6 – Using the mixer for low-latency</b>	<b>25</b>
Manual conventions .....	6	<b>monitoring.....</b>	<b>25</b>
Trademarks.....	6	Uses .....	25
Cautions on installation .....	6	Using the digital mixer for	
Beware of condensation .....	6	monitoring .....	25
Cleaning the unit .....	6	<b>7 – Application guide .....</b>	<b>27</b>
<b>2 – Names and Functions of Parts .....</b>	<b>7</b>	Cubase LE 5.....	27
Front panel.....	7	Windows XP and Windows Media	
Rear panel.....	8	Player.....	27
<b>3 – Installation .....</b>	<b>10</b>	Windows Vista or Windows 7 and	
System requirements .....	10	Windows Media Player.....	27
Windows.....	10	Mac OS X and iTunes .....	28
Mac OS X .....	10	<b>8 – Stand-alone mode .....</b>	<b>29</b>
Installing the driver and control panel	10	Overview.....	29
Installing the driver and control		Settings for stand-alone mode .....	29
panel for Windows .....	11	Mixer .....	29
Installing the control panel for		Output selectors.....	29
Mac OS X .....	12	Sample rate .....	29
Uninstalling the driver.....	12	<b>9 – MIDI implementation chart.....</b>	<b>30</b>
Frequently asked installation		<b>10 – Troubleshooting .....</b>	<b>31</b>
questions and answers (FAQ).....	13	<b>11 – Specifications .....</b>	<b>34</b>
Improving computer performance .....	13	AD/DA audio convertor.....	34
Cubase LE 5 installation .....	13	Inputs .....	34
<b>4 – US-800 control panel settings.....</b>	<b>14</b>	Analog inputs .....	34
Overview.....	14	Digital input .....	34
Control panel menus and settings .....	14	Outputs .....	34
Menu bar items.....	14	Analog outputs.....	34
MIXER and OUTPUT tabs .....	15	Digital output .....	34
Mixer tab screen .....	16	Control I/O.....	34
Output tab.....	19	Audio performance.....	35
<b>5 – Connections.....</b>	<b>22</b>	Computer requirements .....	35
USB connections.....	23	Windows.....	35
Audio connections.....	23	Macintosh .....	35
Microphones .....	23	General.....	35
Guitars.....	23	Dimensional drawing.....	36
Connecting keyboards, drum		Block diagram .....	37
machines, sound modules,			
cassette/MD/CD players and			
other analog line level devices .....	23		
Connecting, sound modules,			
MD/CD players and other digital			
devices .....	23		
Monitor speakers .....	24		

# 1 – Introduction

Thank you for your purchase of the TASCAM US-800 USB 2.0 Audio/MIDI Interface.

Before connecting and using the unit, please take time to read this manual thoroughly to ensure you understand how to properly set up and connect the unit, as well as the operation of its many useful and convenient functions. After you have finished reading this manual, please keep it in a safe place for future reference.

You can also download the Owner's Manual from the TASCAM web site (<http://www.tascam.com>).

Please also check the above site for the latest manual updates.

---

## Main features

---

- Audio interface with 8 inputs and 6 outputs
- Supports audio formats up to 24-bit/96 kHz
- 2 XLR/TS combo jack inputs (balanced mic/unbalanced instrument), 4 XLR/TRS combo jack inputs (balanced mic/line)
- S/PDIF digital input
- +48V phantom power can be supplied to 6 microphone inputs
- 2 unbalanced line outputs, digital output and 2 headphone outputs
- S/PDIF digital output
- Internal digital mixer for direct monitoring of input signals with little delay
- Supports multiple clients, allowing simultaneous use of ASIO and WDM audio protocols
- Two **PHONES** jacks—a stereo phone jack and a stereo mini phone jack—with a combined output of 49 mW + 49 mW (both output the same signal)
- Input monitoring mixer uses digital processing to mix up to 14 ins and 2 outs
- One MIDI IN connector and one MIDI OUT connector

- Stand-alone mode allows use of inputs and outputs without being connected to a computer by USB. In this mode, input signals are output from the output jacks according to the default settings of the mixer and the output selections. This allows the mic preamps to be used without a computer.
- Dedicated drivers for both Windows (Windows XP, Windows Vista, Windows 7) and Mac (OS 10.6)
- Mac USB Audio Class 2.0 compliant
- USB2.0 High speed (480 MHz)
- Cubase LE 5 software included

### A note about computer operation

If you are unsure about how to perform basic computer operations appearing in this manual, please refer to the owner's manual that came with your computer.

---

## Product parts

---

The US-800 package contains the following items.

Take care when opening the package not to damage the items. Keep the package materials for transportation in the future.

Please contact the store where you purchased this unit if any of these items are missing or have been damaged during transportation.

- Main unit..... 1
- AC adaptor (TASCAM PS-P520)..... 1
- Power cord for AC adaptor ..... 1
- USB Cable ..... 1
- CD-ROM (containing drivers) ..... 1
- DVD-ROM (Cubase LE5)..... 1
- Cubase LE5 Quick Start Guide..... 1
- Warranty card..... 1
- Owner's Manual (this document) ..... 1

# 1 – Introduction

## Manual conventions

- Keys, jacks and other parts on the unit and external devices are indicated like this: **PHONES**.
- When we show messages, for example, that appear on the screen, we show them like this: **SONG LOAD**.
- Additional information is introduced in the styles below when needed:

### TIP

*These are tips about how to use the unit.*

### NOTE

*These provide additional explanations and describe special cases.*

### CAUTION

*Failure to follow these instructions could result in injury, damage to equipment or lost recording data, for example.*

## Trademarks

- TASCAM is a trademark of TEAC Corporation, registered in the U.S. and other countries.
- Microsoft, Windows, Windows Vista, Windows 7, and Windows Media Player are either registered trademarks or trademarks of Microsoft Corporation in the United States and/or other countries.
- Apple, Macintosh, Mac, Mac OS X and iTunes are trademarks of Apple Inc.
- Pentium and Intel are trademarks of Intel Corporation in the U.S. and other countries.
- AMD Athlon is a trademark of Advanced Micro Devices, Inc.
- Cubase is a registered trademark of Steinberg Media Technologies GmbH. ASIO is a trademark of Steinberg Media Technologies GmbH.
- Other company names, product names and logos in this document are the trademarks

or registered trademarks of their respective owners.

## Cautions on installation

- The unit's nominal operating temperature is between 5° and 35° C (41° – 95° F).
- Do not install in the following types of places. Doing so could degrade the sound quality and/or cause malfunctions.
  - Places with significant vibrations or that are otherwise unstable
  - Near windows or other places exposed to direct sunlight
  - Near heaters or other extremely hot places
  - Extremely cold places
  - Places with bad ventilation or high humidity
- Make sure that the unit is mounted in a level position for correct operation.
- Do not place any object on the unit for heat dissipation.
- Avoid installing this unit on top of any heat-generating electrical device such as a power amplifier.

## Beware of condensation

If the unit is moved from a cold to a warm place, or used after a sudden temperature change, there is a danger of condensation; vapor in the air could condense on the internal mechanism, making correct operation impossible. To prevent this, or if this occurs, let the unit sit for one or two hours at the new room temperature before using.

## Cleaning the unit

To clean the unit, wipe gently with a soft dry cloth. Do not use any benzene, paint thinner, ethyl alcohol or other chemical agents to clean the unit as they could damage the surface.

# 2 – Names and Functions of Parts

## Front panel

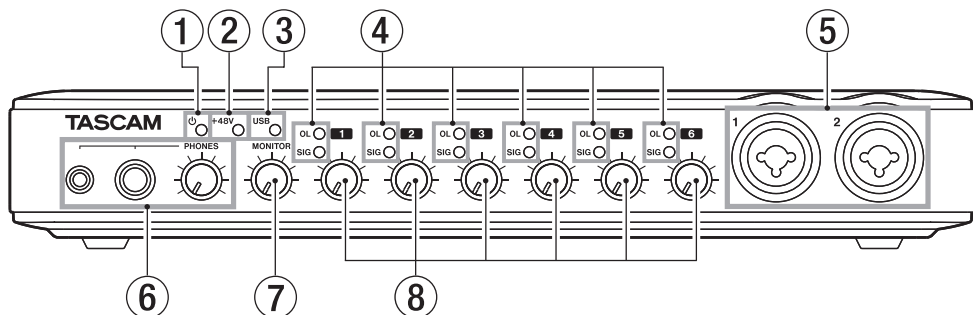

- ① **⏻ (STANDBY/ON) indicator**  
Lights when the power is on.
- ② **+48 indicator**  
Lights when the **PHANTOM (+48V)** switch is set to ON.

### CAUTION

*Do not connect or disconnect microphones when this indicator is lit.*

- ③ **USB indicator**  
Lights when a USB connection is active.
- ④ **OL and SIG indicators**  
OL (overload) indicators  
Light just before an input is about to distort (when  $-2$  dBFS is exceeded).  
SIG (signal) indicators  
Light when a signal is being input on the channel ( $-30$  dBFS or higher).
- ⑤ **MIC/INST IN jacks (balanced/unbalanced)**  
Use these combo jacks to connect both balanced and unbalanced analog microphones and instruments with XLR connectors and standard quarter-inch plugs. Use the XLR connector for microphones (balanced) and the standard jack (unbalanced) for electric guitars, basses and other instruments.
  - XLR (1: GND, 2: HOT, 3: COLD)
  - TS (Tip: HOT, Sleeve: GND)

- ⑥ **PHONES jacks/knob**  
Use the stereo mini jack (PHONES 1) and stereo standard jack (PHONES 2) to connect stereo headphones. The maximum combined output for the stereo mini jack and the stereo standard jack is 49 mW + 49 mW.  
Use the **PHONES** knob to adjust the headphones output.

### CAUTION

*Turn the PHONES knob to the minimum volume before connecting headphones. Failure to do so could cause sudden loud noises and damage hearing, for example.*

- ⑦ **MONITOR knob**  
Adjusts the **LINE OUT L/R** output level.
- ⑧ **Gain knobs**  
Use to adjust the input levels of **MIC/INST IN 1-2** and **MIC/LINE IN 3-6** separately. Turn all the way to the left for the minimum level, and turn all the way to the right for the maximum level.

## 2 – Names and Functions of Parts

### Rear panel

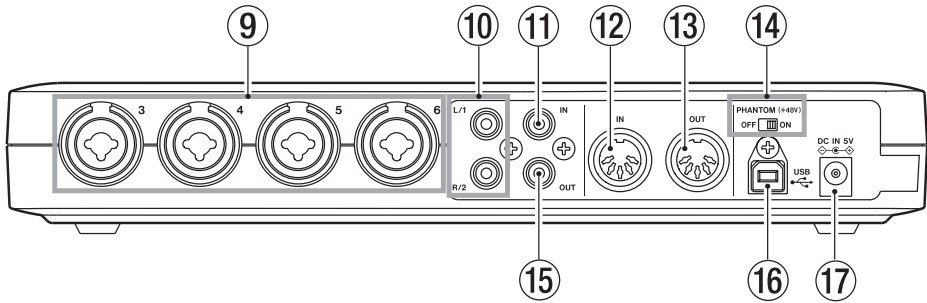

#### ⑨ MIC/LINE INPUTS connectors (balanced)

Use these combo jacks to connect balanced analog microphones and line level inputs. Use the XLR connector for microphones (balanced) and the standard jack (balanced) for keyboards, samplers and other line level devices

- XLR (1: GND, 2: HOT, 3: COLD)
- TRS (Tip: HOT, Ring: COLD, Sleeve: GND)

#### ⑩ LINE OUT jacks (unbalanced) (1/2 or L/R)

Use these RCA jacks for analog line output (unbalanced). These jacks can output signals from a computer connected by USB or the output of the internal monitoring mixer, for example. Set which signals to be output from a computer using the US-800 control panel. Connect these jacks to a recorder, powered speakers or external effect processors, for example.

In stand-alone mode the signals input by **MIC/INST IN 1-2** are output from these jacks.

#### ⑪ DIGITAL IN connector (coaxial)

This coaxial digital input jack conforms to IEC60958-3 (S/PDIF) specifications.

#### NOTE

*This unit is capable of input through its DIGITAL IN jack at 24-bit/96 kHz.*

#### ⑫ MIDI IN connector

This 5-PIN DIN is a standard MIDI input connector for inputting MIDI signals.

#### ⑬ MIDI OUT connector

This 5-PIN DIN is a standard MIDI output connector for outputting MIDI signals.

#### ⑭ PHANTOM (+48V) switch

Use this to turn +48V phantom power on for mic input connectors 1-6.

#### CAUTION

- Always set the PHANTOM (+48V) switch to OFF before turning the unit's power on or off (connecting or disconnecting the AC adaptor).
- Always turn the PHONES and MONITOR knobs to the minimum volume before changing the switch between ON and OFF. Depending on the connected microphone, loud noises might be produced and damage could be caused to equipment and people's hearing.
- Do not connect or disconnect a mic with an input when this switch is ON.
- Turn this switch ON only when connecting a condenser microphone that requires phantom power.
- Do not supply phantom power to an unbalanced dynamic microphone.



## 2 – Names and Functions of Parts

- *Some ribbon mics can be damaged by phantom power. If unsure, do not supply phantom power to a ribbon mic.*

### ⑮ **DIGITAL OUT connector (coaxial)**

This coaxial digital output jack conforms to IEC60958-3 (S/PDIF) specifications. This jack can output signals from a computer connected by USB or the output of the internal monitoring mixer, for example. Set which signals to be output from a computer using the US-800 control panel. Connect this jack to a recorder or external effect processors, for example. In stand-alone mode the signals from **MIC/LINE INPUTS 3-4** are output from this jacks.

### **NOTE**

*This unit is capable of output through its DIGITAL OUT jack at 24-bit/96 kHz.*

### ⑯ **USB port**

Use the included USB cable to connect this unit to a USB 2.0-compatible computer.

### ⑰ **DC IN 5V connector**

Connect the included TASCAM PS-P520 AC adaptor, which meets the specifications of this unit, here.

### **CAUTION**

*Use only the included PS-P520 AC adaptor, which conforms to the specifications of this unit. Use of an adaptor other than this model could cause malfunction, fire or electric shock.*

# 3 – Installation

---

## System requirements

---

See the TASCAM website (<http://www.tascam.com/>) for updated information about OS compatibility.

---

### Windows

**Supported operating systems:**

Windows XP 32-bit SP2 or later

Windows XP 64-bit SP2 or later

Windows Vista 32-bit SP2 or later

Windows Vista 64-bit SP2 or later

Windows 7 32-bit

Windows 7 64-bit

**Supported computer systems:**

Windows compatible computer with a USB 2.0 port

**CPU/clock speed:**

Pentium 4 1.4 GHz or faster

AMD Athlon 1.4 GHz or faster

(or equivalent processor)

**Memory:**

1 GB or more

**NOTE**

*Although this product has been checked for use with typical computers that meet the above operating requirements, we cannot guarantee that it will operate with all computers that meet these requirements. Please be aware that even in the same conditions, computer processing capabilities can vary depending on differences in design and specifications.*

---

### Mac OS X

**Supported operating systems:**

Mac OS X 10.6.3 or later

**Supported computer systems:**

Apple Macintosh equipped with a USB port

**CPU:**

Any Mac with an Intel processor

**Memory:**

1 GB or more

---

## Installing the driver and control panel

---

In order to use this unit, you must install the driver on to your computer. As described below, this is an easy process using the CD-ROM included with the unit.

Drivers are updated from time to time. You can download the most recent version of the driver from the TASCAM website (<http://www.tascam.com/>).

Disconnect the unit from the computer before starting driver installation.

**CAUTION**

- *Handle the enclosed CD-ROM with care. If the disc becomes scratched or dirty, a computer might not be able to read it, making installation of the software impossible. If the included disc becomes unreadable, it can be replaced for a fee.*
- *Never attempt to play the enclosed CD-ROM in an ordinary audio CD player, as the resulting noise could damage the speakers or harm your hearing.*

# 3 – Installation

## Installing the driver and control panel for Windows

### NOTE

During driver installation, a warning that “this software ... has not passed Windows Logo testing” will appear.

This message appears when installing a driver that has not received Windows Logo testing.

This message appears because the drivers for TASCAM products have not undergone Windows Logo testing. We have, however, confirmed their proper operation.

If this message appears, click “Continue” or “Install” to proceed with the installation.

### Installation on a Windows computer

- 1 Confirm that the unit and the PC are not connected by a USB cable.
- 2 Insert the included driver installation CD-ROM into the PC where you will install it.
- 3 Open the included driver CD-ROM and launch the “setup.exe” file inside “US-800 Win Driver” folder.
- 4 When the following screen appears, click the “Next” button.

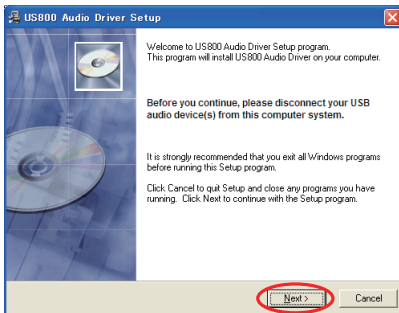

- 5 The Windows installation location screen appears. Select where to install the driver, and click the “Next” button.

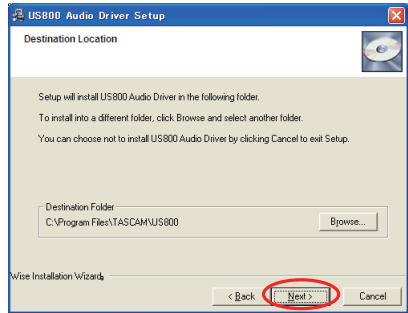

- 6 When the following screen appears, click the “Next” button.

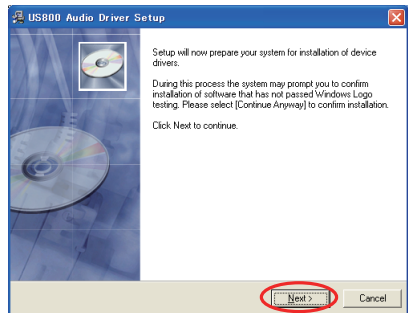

- 7 When the following screen appears, connect the unit with the computer using the included USB cable, and then plug the included AC adaptor (TASCAM PS-P520) into the unit.

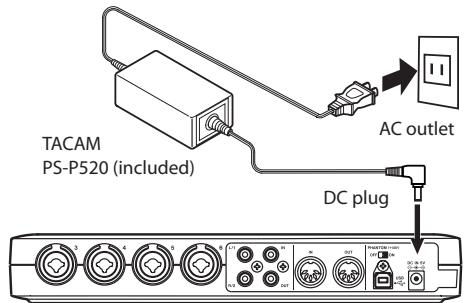

# 3 – Installation

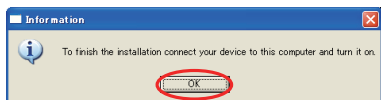
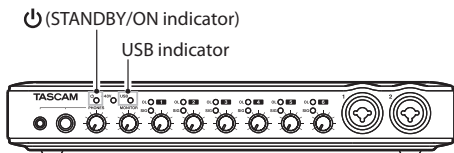

Confirm that the unit's (STANDBY/ON) and USB indicators have lit, and then click the "OK" button.

8 When Windows recognizes the US-800, driver installation starts automatically.

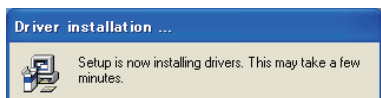

9 After installation completes, the icon shown below appears in the notification area (the system tray).



Click this icon to open the US-800 control panel.

10 If the versions appear in the "DRV Ver.," and "F/W Ver." fields in the "STATE" section of the "OUTPUT" screen, installation has been successful.

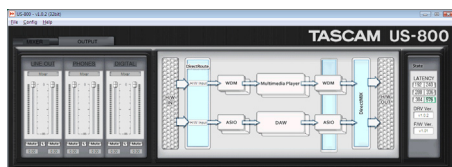

## Installing the control panel for Mac OS X

This unit uses the class 2.0 compliant USB driver provided by Apple Inc., so installation

of only the control panel is necessary when using a Mac.

- 1 Confirm that the unit is not connected to the computer.
- 2 Double-click the "US-800 Panel.app.dmg" on the included driver CD-ROM. A disk image named "US-800Panel" should appear on the computer. (Depending on the Finder Preferences settings, it will appear on the desktop or in a Finder window Sidebar. If it does not appear in either of these places, select "Computer" from the "Go" menu of the Finder). Click on this image to open it.



- 3 Copy the "US-800 Panel" (program icon) to the computer desktop, the Applications folder or another location of your choice.



US-800 Panel

- 4 In the Finder, close the "US-800 Panel" (disc image) folder.
- 5 Restart the computer, and connect the unit with the computer to use it.

## Uninstalling the driver

### ■ Windows XP

- 1 Open the "Control Panel" from the "Start" menu and double-click "Add or Remove Programs".
- 2 Select "US800 Audio driver" from the list and click the "Change or Remove Programs" button.

**3 Follow the instructions on the screen to complete the uninstallation.**

### ■ Windows Vista and Windows 7

- 1 Open the “Control Panel” from the “Start” menu and double-click the “Programs and Features” icon.**
- 2 Select “US-800 Audio driver” from the list and click the “Uninstall” button.**
- 3 Follow the instructions on the screen to complete uninstallation.**

### ■ Mac OS X

Move the “US-800 Panel” application icon to the Trash.

---

## Frequently asked installation questions and answers (FAQ)

### Windows driver installation

- Q:** When I connect the unit to a computer, the Windows Hardware Wizard appears and I cannot install the driver. Am I making a mistake during the installation procedures?
- A:** Close the Windows “Hardware Wizard” and disconnect the unit. You must install the driver before connecting this unit. See “Installing the driver and control panel for Windows” on page 11 for the correct procedures.
- Q:** I loaded the installation CD-ROM into a Windows computer, but the driver installation menu does not appear. How can I access this menu?
- A:** The driver CD-ROM does not launch automatically. Follow the procedures in “Installing the driver and control panel for Windows” on page 11 to install the driver.

---

## Improving computer performance

---

In this manual, we will offer only the following basic tip to improve performance when using this unit.

### Do not run other applications.

Processing digital audio places a considerable load on your computer. You probably use the computer for applications other than audio, but we recommend that you avoid running them when using audio programs. This means that if you are running other applications (especially ones that are graphics-intensive or that use Internet tools) at the same time as an audio application, processing may not be able to keep up the audio data.

---

## Cubase LE 5 installation

---

See the included Cubase LE 5 Quick Start Guide for details.

# 4 – US-800 control panel settings

## Overview

The Control Panel lets you make various settings related to how this unit functions.

On Windows, the Control Panel icon appears in the notification area (the system tray).

On Mac OS X, the Control Panel is located wherever you put it during installation. Double-click the icon to open the control panel.

Other important audio settings for Mac OS X can be made using the Audio MIDI Setup program, which is in the “Applications/Utilities” folder.

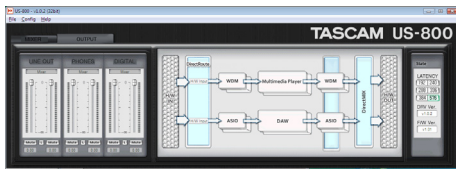

Windows control panel screens

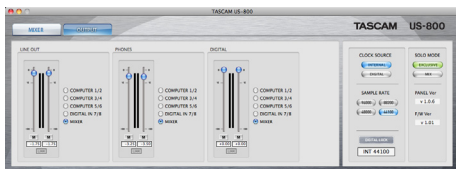
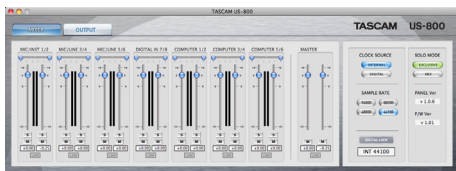

Mac OS X control panel screens

## Control panel menus and settings

### Menu bar items

#### ■ Windows OS

##### File

- Close Window:  
Closes the window

##### Config

- Mouse Wheel  
Sets the amount of movement per count when using a mouse scroll wheel to raise and lower the virtual faders.  
Settings: Step1 (default value), Step2, Step4, Step8
- Latency  
According to the performance of the computer system, you can change the size of the audio input and output signal buffer that the unit's driver stores temporarily.  
Settings:  
192, 240, 288, 336, 384, 576 (default value)

#### NOTE

- All applications that connect to the US-800 must be closed before the latency can be changed.
- Increase the buffer size if the computer has insufficient processing power and noise occurs. Increasing the buffer size, however, also increases latency (audio signal delay). Set this value to best suit your system.
- Samplerate  
Sets the sampling frequency used.  
Settings: 44100 (default value), 48000, 88200, 96000 Hz
- Clock:  
Set whether the unit uses its internal clock or a digital clock signal input through its **DIGITAL IN** connector.  
Settings: Internal (default value), Digital In

## 4 – US-800 control panel settings

- **Factory Default**  
Use this to restore the software to its factory default settings. Click “OK” when the confirmation screen appears.
- **Always on Top**  
Set this to make the control panel always appear in front of other windows. A check mark appears before this item when selected.

### Help

- **About**  
Select to open a pop-up window that shows the version of the US-800 control panel software.

### ■ Mac OS

#### US-800 Panel

- **About US-800 Panel**  
Select to show the version of the US-800 control panel software.
- **Hide US-800 Panel**  
Select to hide the US-800 control panel.
- **Hide Others**  
Select to hide software other than the US-800 control panel.
- **Show All**  
Select to show all running software.
- **Quit US-800 Panel**  
Select to quit the US-800 control panel software.

#### Configuration

- **Restore Factory Defaults**  
Use to restore the software to its factory default settings.
- **Always on Top**  
Select to make the control panel always appear in front of other windows.

#### Window

- **Minimize**  
Select to minimize the control panel window.
- **Zoom**  
This has no effect with this software.

- **Bring All to Front**  
Select to bring all the control panel software windows to the front.

---

### MIXER and OUTPUT tabs

Click this to switch between the MIXER tab and the OUTPUT tab.

In Windows OS, the selected tab appears to be in front.

In Mac OS, the selected tab button appears lit.

# 4 – US-800 control panel settings

## Mixer tab screen

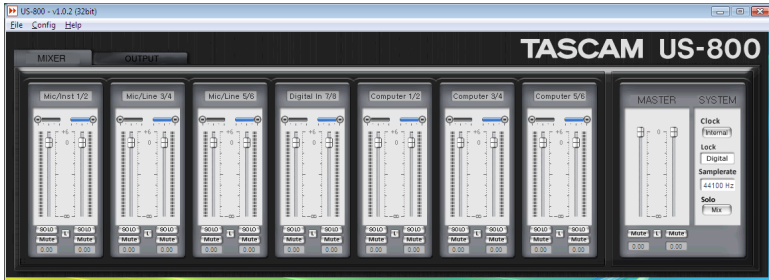

Windows control panel

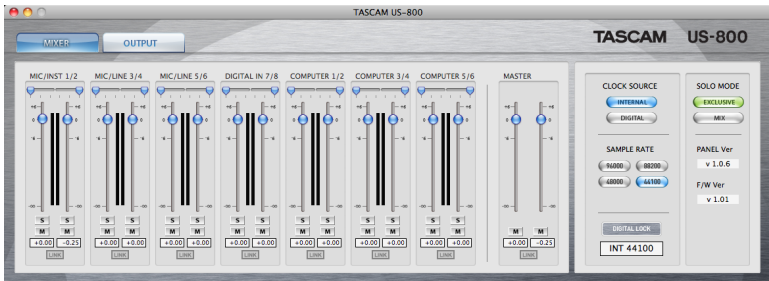

Mac control panel

Click the **MIXER** tab to open the **MIXER** screen where you can make internal mixer settings. The 14 faders on the left are the input faders. In order from the left, they are 6 channels of analog inputs, 2 channels of digital inputs and 6 channels of signals from the computer. The 2 faders on the far right are the left and right stereo master faders.

### ■ Input fader pair

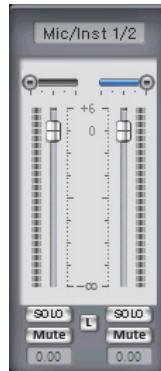

Windows

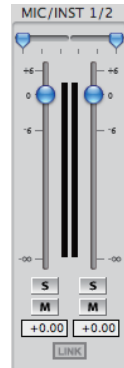

Mac

### Input fader display

The name of each input fader is shown.



## 4 – US-800 control panel settings

### Pan sliders

Set the pan for each channel in a range of L15 - C - R15. When set all the way to the left (L15), the input signal is sent entirely to the left channel (0 dB), and no signal is input to the right channel ( $-\infty$ ). When set all the way to the right (R15), this is reversed. When pan is set to center (C), the signal is sent equally to both left and right channels with a  $-3$  dB reduction on both sides.

When "Stereo link" is ON, sliders set the balance between left and right channels (as the left becomes louder, the right becomes quieter and vice versa). One slider is shown for both linked channels.

### Input level meters

These show the input levels of each channel. For input 1-8 signals, the pre-fader levels are shown. For computer 1-6 signals, the post-fader levels are shown.

### Input faders

Use these faders to adjust the mixer input levels in a range from  $-\infty$  to  $+6$  dB.

#### NOTE

*In the following explanations, the Windows version of the software is described first. When the Mac version has a significant difference, it is described second. Mac version part names are indicated in parentheses.*

### SOLO (S) buttons

When a "SOLO" button is turned ON, only channels with "SOLO" buttons turned ON have their signal sent to the stereo bus. All other channels are muted. When the SOLO mode is set to "Mix", SOLO can be turned ON for multiple channels. If set to "Exclusive", only the last channel that was set to SOLO can be heard.

ON: lit

OFF (default value): unlit

### Mute (M) buttons

Use these to mute channels.

ON: lit

OFF (default value): unlit

### L (LINK) buttons

Use these stereo link buttons to synchronize the operation of the left and right channel faders in a pair.

This also joins the pan sliders into a single balance slider.

ON: lit

OFF (default value): unlit

### Fader level displays

The current level of each fader is shown in decibels. In the Mac version, if you move a PAN slider, the pan position (L15 - C - R15) is shown momentarily instead.

### Master fader section

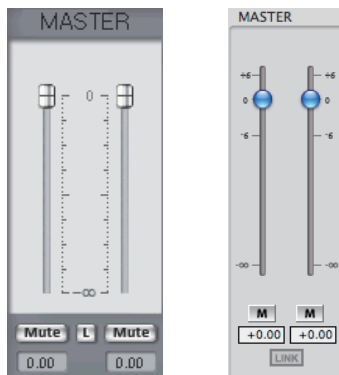

Windows

Mac

### Master fader

The stereo master faders include a fader for both left and right channels. If the stereo link is disabled, moving these faders separately is possible.

### Mute (M) buttons

Use these to mute channels.

ON: lit

OFF (default value): unlit

## 4 – US-800 control panel settings

### L (LINK) button

Use this stereo link button to synchronize the operation of the left and right master faders.

- ON (default value): lit
- OFF: unlit

### Fader level display

The current level of each fader is shown in decibels.

### ■ System settings section

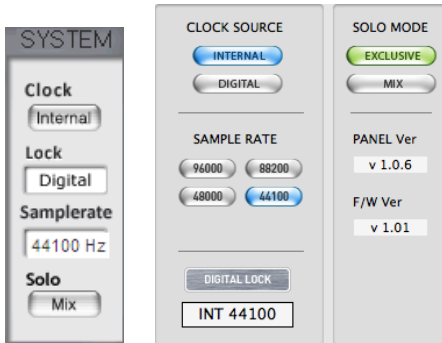

Windows

Mac

### Clock (CLOCK SOURCE)

Use this to set the Sample Clock source.

On Windows, change the setting by clicking the button.

On Mac, click the button for the desired setting.

Internal (default value): US-800 uses its internal clock

Digital (DIGITAL): Clock signal received through **DIGITAL IN** connector used

### Lock (DIGITAL LOCK) indicator

This shows whether the clock is in sync or not. It lights when in sync.

### Samplerate (SAMPLE RATE)

Use to set the sampling frequency. When "Clock (CLOCK SOURCE)" is set to "Internal (INTERNAL)", it can also be used to set it.

On Windows, use the pull-down menu to select the value. On Mac, click the corresponding button.

Settings: 44100 (default setting), 48000, 88200, 96000 Hz

When "Clock (CLOCK SOURCE)" is set to "Digital (DIGITAL)", the sampling frequency is automatically set.

### Solo (SOLO MODE)

Set the Solo mode to "Mix" or "Exclusive".

On Windows, change this by clicking the button.

On Mac, click the button for the desired setting.

- MIX (default value): Multiple tracks can be soloed together.
- EXCLUSIVE: Only one channel or one stereo pair of channels can be soloed at a time. If this mode is in use, when a new channel is soloed, Solo will be turned OFF for any currently soloed channel.

### Panel Ver. (Mac only)

This shows the version of the control panel software.

#### NOTE

On Windows, this is shown on the "OUTPUT" tab screen.

### F/W Ver. (Mac only)

This shows the firmware version of the device.

#### NOTE

On Windows, this is shown on the "OUTPUT" tab screen.

# 4 – US-800 control panel settings

## Output tab

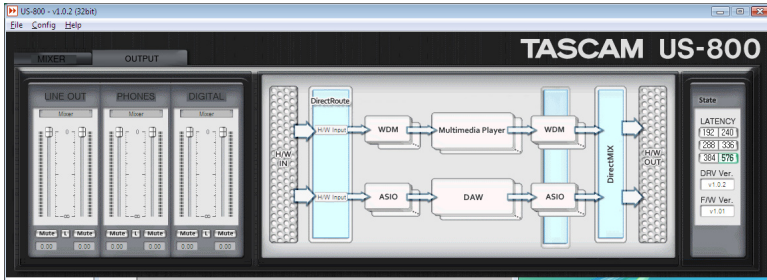

Windows control panel

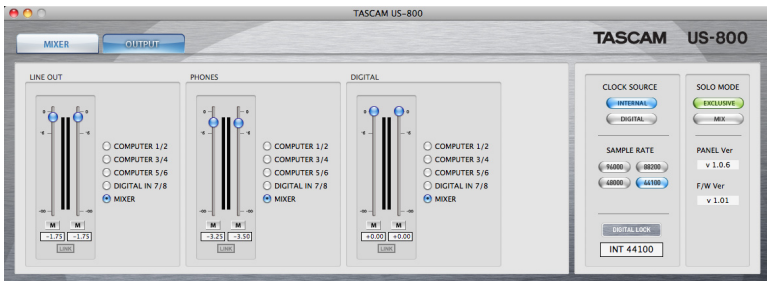

Mac control panel

Click the “OUTPUT” (OUTPUT) tab to open the corresponding window where you can make output settings.

### ■ Fader section

Use these three pairs of faders to set the US-800 output. You can make “LINE OUT”, “PHONES OUT” and “DIGITAL OUT” settings.

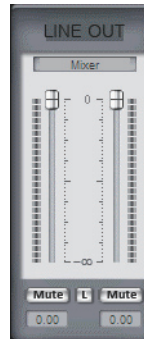

Windows

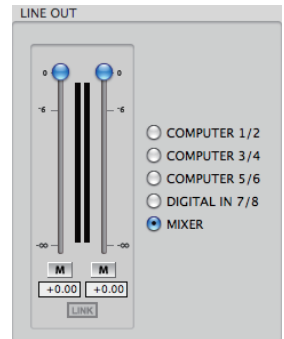

Mac

### Output name display

The names of the faders are shown.

# 4 – US-800 control panel settings

## OUTPUT selectors

You can set the LINE OUT, PHONES and DIGITAL outputs to the following options.

Setting	Description
Computer1/2	Signals 1-2 from the computer
Computer3/4	Signals 3-4 from the computer
Computer5/6	Signals 5-6 from the computer
Digital In	Signal from the <b>DIGITAL IN</b> connector
Mixer (default value)	Output signals from the internal mixer

## Level meters

These show the levels immediately after the faders.

## Faders

Use these to adjust the output levels in a range from  $-\infty$  to 0 dB.

## Mute (M) buttons

Use to mute individual channels.

ON: lit

OFF (default value): unlit

## L (LINK) buttons

Turn these stereo link buttons ON to synchronize the operation of left and right channel fader pairs.

ON (default value): lit

OFF: unlit

## Fader level display

The current level of each fader is shown in decibels.

## Direct I/O section (Windows only)

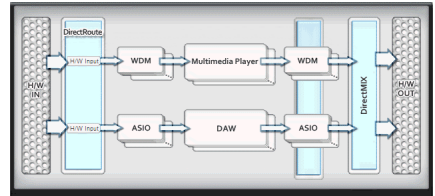

## Direct I/O

By using Direct I/O in the US-800 driver, audio signals can be exchanged between applications that use different interfaces. Using this function, the following types of operations are possible.

- Record the playback sound of a multimedia player into a DAW that uses ASIO.
- Record the output of an ASIO DAW into a WDM application.
- Send the US-800 input signal to a WDM application.

Make settings in the “DirectRoute” area, which is second from the left after the “H/W IN” area. Click on a box in the “DirectRoute” to open a pull-down menu. Select the input signal for each interface from this menu. The following settings are possible.

- WDM input settings

Setting	Description
H/W Input (default setting)	US-800 input signals
ASIO	ASIO application output signals

- ASIO input settings

Setting	Description
H/W Input (default setting)	US-800 input signals
WDM	WDM application output signals

## NOTE

When making settings, be careful not to create a signal loop.

## 4 – US-800 control panel settings

### ■ STATE section (Windows only)

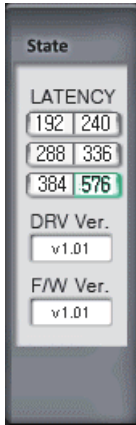

This shows system settings and driver and firmware versions.

#### **LATENCY**

Sets the latency of the USB driver.

Settings: 192, 240, 288, 336, 384, 576  
(default value)

#### **NOTE**

- *All applications that connect to the US-800 must be closed before the latency can be changed.*
- *Increase the buffer size if the computer has insufficient processing power and noise occurs. Increasing the buffer size, however, also increases latency (audio signal delay). Set this value to best suit your system.*

#### **DRV Ver.**

This shows the driver version.

#### **F/W Ver.**

That shows the firmware version installed in the unit.

### ■ System setting section (Mac only)

This is the same as the system settings section on the mixer tab screen.

#### ■ About latency

This unit's driver momentarily stores audio input and output signals in a buffer. The size of the buffer can be adjusted.

The smaller the buffer is, the shorter the delay is when monitoring the input audio signal. Smaller buffers, however, require more computer processing at high speed. If other system processes, for example, prevent the audio processing from being completed in time, clicking and popping noises, dropouts and other issues could occur with the audio signal.

On the other hand, the larger the buffer size, the more stable operation becomes, making interference from other system processes less likely to affect the audio signal. However, the delay when monitoring the audio signal also becomes longer.

With this unit, you can adjust the buffer size according to the capability of your system and your audio needs.

# 5 – Connections

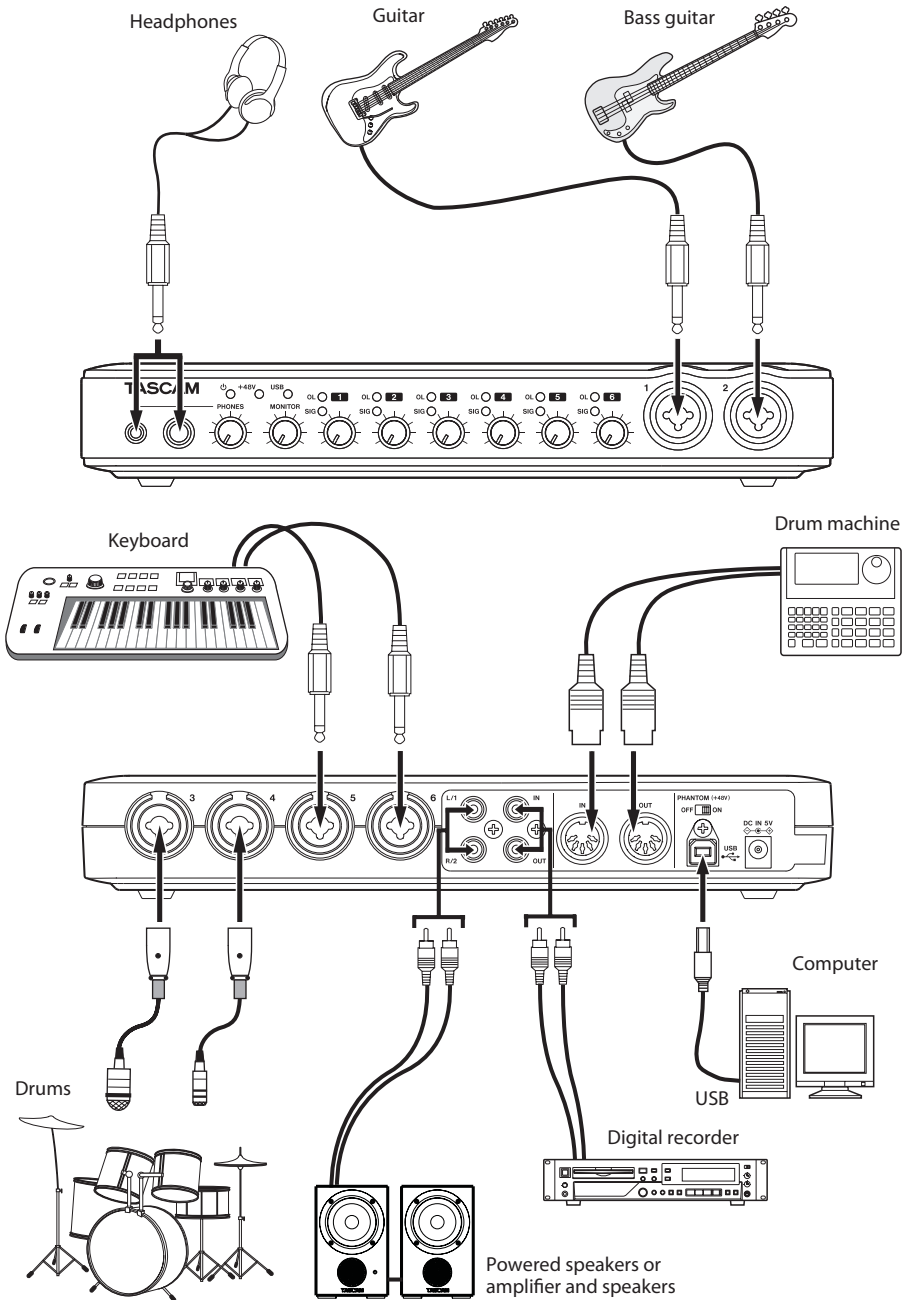

Example of using US-800 connections

---

## USB connections

---

Use the included USB cable to connect the US-800 to your computer as shown in the illustration.

### NOTE

Some USB devices access the USB bus frequently. To avoid dropouts and clicks in the audio signal, we strongly recommend that you do not connect any USB devices other than keyboards and mice to the USB bus used by this unit.

---

## Audio connections

---

Connect the analog outputs of microphones, guitars, keyboards and other audio devices to this unit, which will convert their signals into digital signals and send them via USB to your computer.

Connect the outputs of the unit to speakers (with amplification) and headphones to monitor a mix of the audio signals being input into the unit and output from the computer.

You can adjust the level, pan and other settings for each signal. (For details, see “6 - Using the mixer for low-latency monitoring” on page 25.)

---

## Microphones

Connect microphones to the **MIC/INST IN (1-2)** XLR jacks on the front panel or the **MIC/LINE INPUTS (3-6)** XLR jacks on the rear panel. If you are using a condenser mic that requires phantom power, set the **PHANTOM +48V** switch on the rear panel to ON.

### CAUTION

- *Connecting a dynamic microphone with an unbalanced connection to the unit when the PHANTOM +48V switch is ON could damage this unit and make it unusable.*

- *Do not connect or disconnect a mic with an input when this switch is ON. Loud noises might be produced and damage could be caused to equipment.*
- *Always turn the PHONES and MONITOR knobs on the front panel to the minimum volume before changing the PHANTOM +48V switch between ON and OFF. Depending on the connected microphone, loud noises might be produced and damage could be caused to equipment and harm could occur to people's hearing.*
- *Always set the PHANTOM (+48V) switch to OFF before turning the unit's power on or off (connecting or disconnecting the AC adaptor).*

---

## Guitars

When connecting guitars and bass guitars to this unit directly, use the **MIC/INST IN (1-2)** 1/4" jacks on the front panel.

---

## Connecting keyboards, drum machines, sound modules, cassette/MD/CD players and other analog line level devices

Connect the analog signal outputs of these types of equipment to the **MIC/LINE INPUT 3-6** jacks (standard TRS) on the rear panel.

---

## Connecting, sound modules, MD/CD players and other digital devices

Connect the external device's digital output to the IN connector on the rear panel of this unit. To send this unit's signal to another device, connect the US-800's **DIGITAL OUT** to the other device's digital input.

### NOTE

- *The digital input and output connectors of this unit are RCA pin jacks.*

## 5 – Connections

- *This unit can handle S/PDIF digital input and output signals.*

---

### Monitor speakers

Connect monitor speakers (powered speakers or an amplifier and speakers) to the **LINE OUT** jacks on the rear panel.

---

### Headphones

Connect headphones to the standard stereo **PHONES** jacks on the front panel. This unit has one quarter-inch (6.3-mm) stereo standard jack and one eighth-inch (3.5-mm) stereo mini jack. Use the one suitable for your headphones.

You can also use both at the same time. When doing so, the combined output from both jacks is 49 mW + 49 mW.

---

### Connecting MIDI devices

You can connect keyboards, synthesizers, drum machines and other MIDI devices to the MIDI input. You can also, for example, connect sound modules to the MIDI output. You can also use the **MIDI IN** and **MIDI OUT** connectors to send and receive MTC (MIDI timecode). By doing this, you can synchronize a multitrack recorder that is compatible with MTC and MIDI devices using the computer application.



# 6 – Using the mixer for low-latency monitoring

In this chapter, we explain how to create low latency mixes for monitoring, including how to use the various settings and specific examples.

## Uses

By using this unit's digital mixer for monitoring, inputs can be monitored with very little delay.

For example, this is useful when a performer wants to monitor the output of a guitar that is connected to an input on this unit.

Ordinarily, sending the signal from the unit to the computer by USB through an application on the computer and then back to the unit by USB again takes approximately 20 ms or longer.

In this case, the performer does not hear the sound of the guitar until approximately 20 ms or longer have passed, making it very difficult to play.

This unit has a digital mixer that can be used to avoid this situation. Using this mixer, you can mix the input signals with playback signals from the computer and output them from the unit.

The input signals sent to the mixer do not get sent over USB, allowing them to be mixed and output with very little latency. As a result, the delay until the performer hears the sound of the instrument is reduced to an insignificant amount.

Moreover, the digital mixer includes faders, pan sliders, mute and solo buttons, as well as level meters, allowing you to tailor the monitoring mix as desired.

## Using the digital mixer for monitoring

In this example, a guitar is playing along with a backing track output from a computer application. The sound of the guitar is mixed

with the playback sound of the backing track from the application, and the mix is output to headphones for monitoring. The guitar is connected to the **MIC/INST 1** jack and headphones are connected to one of this unit's **PHONES** jacks.

- 1 **Open the unit's control panel, and click the "MIXER" tab to open the "MIXER" screen.**



Windows control panel MIXER tab

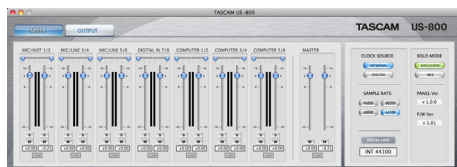

Mac control panel MIXER tab

- 2 **Play the guitar and confirm that the "MIC/INST 1" meter moves.**
- 3 **Output the sound of the computer application to US-800 1/2 port for monitoring. The "Computer 1/2" channel meters on the "MIXER" screen should move when you do so.**
- 4 **Click the "OUTPUT" tab.**
- 5 **When the output tab screen opens, in the "PHONES" area of the three output sections on the left, set the output source selector to "Mixer". This sends the mixer output to the headphones output jacks.**

Set this way, the mixed sound of the computer application playing back and the MIC/INST 1 input signal is sent to the headphones.

## 6 – Using the mixer for low-latency monitoring

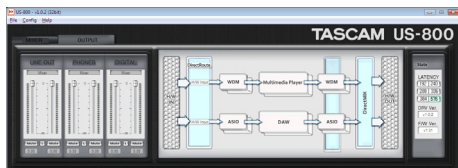

Windows control panel OUTPUT tab

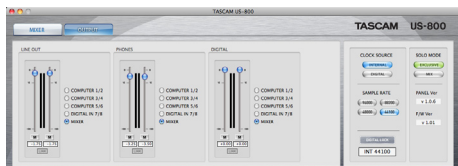

Mac control panel OUTPUT tab

- 6 Adjust the headphones output volume using the fader in the “PHONES” area of the output screen and the PHONES knob on the front panel of the unit.**
- 7 Use the faders on the mixer screen to adjust the balance between the guitar and application playback sounds.**
- 8 To place the guitar sound in the center, set the Mic/Inst 1 pan to center (C).**
- 9 If you want to eliminate all sound from the unused channels, set their “Mute” buttons to ON or set the “SOLO” buttons for “Mic/Inst 1” and “Computer 1/2” to ON (solo mode must also be set to “Mix”).**

The above procedures are only an example. You could also use other input jacks and use Computer 3/4 instead of Computer 1/2 for the playback sound. You can even use all the mixer channels at once. When using numerous channels, be sure to adjust their faders to avoid clipping noise in the mix.

# 7 – Application guide

In this chapter, we explain how to set up some audio applications for use with this unit.

---

## Cubase LE 5

---

For details see the included Cubase LE 5 Quick Start Guide.

---

## Windows XP and Windows Media Player

---

- 1 **Close all applications and then open the “Control Panel” from the “Start” menu.**
- 2 **Open “Sounds and Audio Devices.”**

### NOTE

If you do not see the above item, click “Sounds, Speech, and Audio Devices” and it should appear.



Sounds and Audio Devices

- 3 **Click the “Audio” tab, and set the “Default device:” for “Sound playback” to “US800”.**

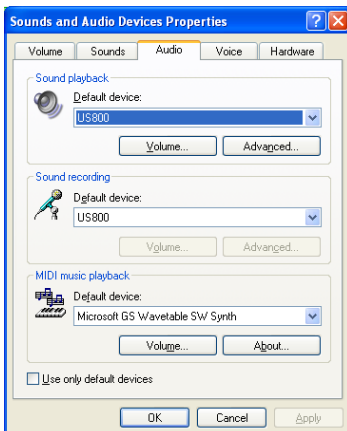

- 4 **Click “OK.”**

- 5 **Start Windows Media Player, select an audio file and begin playback.**

### NOTE

- If you change this setting while Windows Media Player is running, the software will not recognize that the device has been changed. In this case, restart Windows Media Player.
- If you still cannot hear sound after making the setting and completing the procedures above, restart the computer.
- After making this setting, sound will be output through this unit, but no sound will be output by the computer’s speakers or headphone jacks.

---

## Windows Vista or Windows 7 and Windows Media Player

---

- 1 **Close all applications and then open the “Control Panel” from the “Start” menu.**
- 2 **Open “Sound”.**

### NOTE

If the above item does not appear, click “Hardware and Sound” and it should appear.



Sound

- 3 **Click the “Playback” tab, click “Speakers US-800” and click the “Set Default” button. This moves the green check mark to “Speakers US800 Audio.”**

# 7 – Application guide

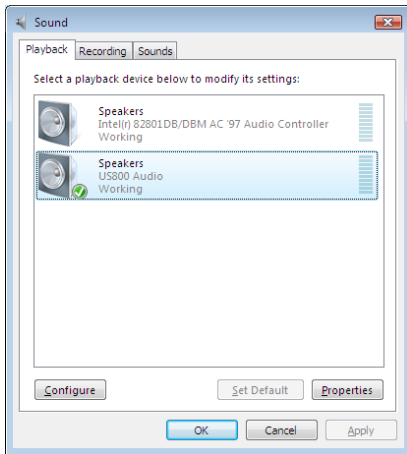

- 4 Click "OK."
- 5 Start Windows Media Player, select an audio file and begin playback.

### NOTE

- If you change this setting while Windows Media Player is running, the software will not recognize that the device has been changed. In this case, restart Windows Media Player.
- If you still cannot hear sound after making the setting and completing the procedures above, restart the computer.
- After making this setting, sound will be output through this unit, but no sound will be output by the computer's speakers or headphone jacks.

## Mac OS X and iTunes

- 1 Open the "Utilities" folder, which is inside the "Applications" folder, and double-click "Audio MIDI Setup" to launch it.
- 2 Control-click the "US-800". Check "use this device for sound input" and "use this device for sound output". This moves microphone icon and speaker icon to "US-800."

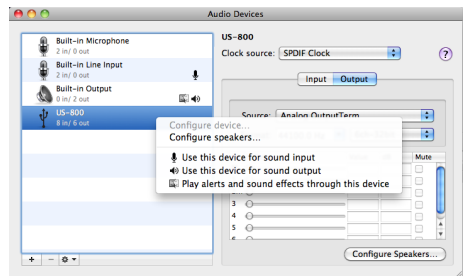

- 3 Launch iTunes, select an audio file and start playback.

# 8 – Stand-alone mode

---

## Overview

---

When this unit is not connected to a computer by a USB cable and the unit's power is ON (the included TASCAM PS-P520 AC adaptor is connected), the unit will operate in stand-alone mode. In this mode, you can use this unit as a microphone preamp without using a computer.

---

## Settings for stand-alone mode

---

In stand-alone mode, input signals pass through the digital mixer, which is set to fixed values, and then the output selectors before being output from the output jacks.

---

### Mixer

The mixer settings are fixed at the following values.

- Faders: All set at 0 dB
- Pan: Odd channels are set to the left channel and even channels are set to the right
- Mute: All OFF
- Solo: All OFF
- Stereo link: OFF

---

### Output selectors

Output selector settings are fixed at the following values.

- LINE OUT: 1/2
- PHONES: MIXER
- DIGITAL OUT: 3/4

---

### Sample rate

When the digital input is active, "Clock" is set to "DIGITAL" and the sample rate depends on the digital input. When the digital input is not active, "Clock" is set to "Internal" and the sample rate is set to "44.1 kHz".

# 9 – MIDI implementation chart

Function		Transmitted	Received	Remarks
Basic Channel	At power ON Changed	X	X	Through
		X	X	
Mode	At power ON Messages Altered	X	X	Through
		X	X	
		*****		
Note Number	Range	X	X	Through
		*****		
Velocity	Note ON Note OFF	X	X	Through
		X	X	
After Touch	Polyphonic Channel	X	X	Through
		X	X	
Pitch Bender		X	X	Through
Control Change		X	X	Through
Program Change	Range #	X	X	Through
		*****		
System Exclusive		X	X	Through
System Common	Song Pos Song Sel Tune	X	X	Through
		X	X	
		X	X	
System Real Time	Clock Commands	X	X	Through
		X	X	
Other	Local on/off All note off Active sensing Reset	X	X	Through
		X	X	
		X	X	
		X	X	
Notes				

Mode 1: Omni on, Poly  
Mode 3: Omni off, Poly

Mode 2: Omni on, Mono  
Mode 4: Omni off, Mono

O: Yes  
X: No

# 10 – Troubleshooting

Please read this chapter if you are unable to use the unit properly even after setting it up following the procedures in this manual.

If you are still unable to resolve your problems please contact TASCAM customer support with the following information about the operating environment and details about the trouble.

## Operating environment

- Computer manufacturer
- Model
- CPU
- Installed memory
- OS
- Applications used
- Antivirus software use
- Wireless LAN use

Please see the back of this manual for contact information.

## ■ Installation fails. Installation completes, but the computer does not recognize the unit.

If some trouble is causing installation to fail, or installation completes but the computer does not recognize the unit, check the following.

- 1) USB indicator lit  
Is the USB indicator on the front panel of the unit lit? If the USB indicator is not lit, confirm that the USB cable is properly connected.

## NOTE

*Always use the included USB cable.*

- 2) Change the USB port  
Since the unit might not function properly with some USB ports, try connecting to a different built-in USB port on the computer, and reinstall the driver (when using Windows).

## NOTE

- *Try again after disconnecting other USB devices. (Keyboards and mice can be left connected.)*
  - *Do not use a USB hub. Always connect the unit directly to a built-in USB port on the computer.*
- 3) Stop other software running in the background  
Since antivirus software and other software that runs in the background can interfere with installation, stop other software before beginning installation. See “3 – Installation” on page 10 of this manual for how to install and uninstall the driver.

## ■ There is no sound even when audio is playing back.

The audio output must be set on the computer.

Please confirm the following while the unit is connected to the computer.

Note that after making the following settings, sound will be output through the unit, but no sound will be output by the computer's speakers or headphone jacks.

## Windows XP

- 1 **Shut down all applications, and open the “Control Panel” from the “Start Menu.”**
- 2 **Open “Sounds and Audio Devices”**

## NOTE

*If do not see the above item, click “Sounds, Speech, and Audio Devices” and it should appear.*

- 3 **Click the “Audio” tab, and set the “Default device:” for “Sound playback” and “Sound recording” to “TASCAM US-800.”**

# 10 – Troubleshooting

## Windows Vista and Windows 7

- 1 **Shut down all applications, and open the “Control Panel” from the “Start” menu.**
- 2 **Open “Sound.”**

### NOTE

*If the above item does not appear, click “Hardware and Sound” and it should appear.*

- 3 **Click the “Playback” tab, right-click “Speakers US-800” and click the “Set Default” button.**

## Mac OS X

- 1 **Shut down all applications and open “System Preferences” from the Apple menu.**
- 2 **Open “Sound.”**
- 3 **From the “Output” tab, select “US-800 Output.”**

After completing the settings, restart the computer and check the playback sound.

Depending on the application you are using, other device settings might also be necessary in addition to those above.

In particular, since DAW (Digital Audio Workstation) software operates using audio engines that are different from OS settings, confirm the DAW driver settings first after installing the driver for this unit. Check the manuals for the software that you are using for details about how to make these settings.

For the bundled Cubase LE 5 software, see the manual on the included Cubase LE 5 DVD-ROM.

### ■ **The sound breaks up or there is noise.**

The processing load on the computer can cause sound to break up and noise to occur. Some ways to reduce the load on a computer are introduced below.

- 1) If a wireless LAN, antivirus software or other software are running in the

background, they regularly use the computer’s CPU, and this burden can cause sound to break up and noise to occur.

Stop wireless LAN transmission, antivirus software and other software running in the background when using this unit.

- 2) Try increasing the buffer size (latency) setting in the audio application that you are using and/or in the control panel for this unit.

### NOTE

*Consult the maker of your audio application for methods to reduce its burden on your computer.*

- 3) Change the settings of your computer so that they are optimal for audio processing.

## Windows XP

- 1 **Right-click “My Computer” and select “Properties.”**
- 2 **Click the “Advanced” tab.**
- 3 **Click “Settings” in the “Performance” section.**
- 4 **On the “Performance Option” screen, select the “Adjust for Best Performance” option.**

## Windows Vista

### a) **Turn Aero off.**

- 1 **Right-click the desktop and select “Personalize”**
- 2 **Choose “Window Color and Appearance” and then click “Open classic appearance properties for more options.”**
- 3 **Select “Windows Vista Basic” or any option other than “Windows Aero.”**



## b) Performance settings

- 1 **Right-click “Computer” and select “Properties”.**
- 2 **Click “Advanced system settings.”**
- 3 **Click the “Advanced” tab.**
- 4 **Click “Settings” in the “Performance” section.**
- 5 **On the “Performance Option” screen, select the “Adjust for Best Performance” option.**

## Windows 7

### a) Turn Aero off.

- 1 **Right-click the desktop and select “Personalize”.**
- 2 **Select any theme from among “Basic and High Contrast Themes”.**

### b) Performance settings

- 1 **Right-click “Computer” and select “Properties”.**
- 2 **Click “Advanced System Settings”.**
- 3 **Click the “Advanced” tab.**
- 4 **Click “Settings” in the “Performance” section.**
- 5 **On the “Visual Effects” tab in the “Performance Options” window, select “Adjust for best performance”.**

## Mac OS X

- 1 **Open “System Preferences” from the Apple menu and select “Energy Saver.”**
- 2 **Click the “Sleep” tab.**
- 3 **Set “Put the computer to sleep when it is inactive for:” to “Never.”**
- 4 **Set “Put the display(s) to sleep when the computer is inactive for:” to “Never.”**
- 5 **Click the “Options” tab. If a “Processor performance” setting is available, set it to “Highest.”**

## NOTE

*Depending on the Mac OS version and model these settings might not be available.*

## ■ Questions related to Cubase LE 5

Since Cubase LE 5 is a product provided by Steinberg Media Technologies GmbH, it is not supported by TASCAM.

Please use the Cubase LE 5 Help menu for information about how to use this software.

# 11 – Specifications

---

## AD/DA audio convertor

---

### Sampling frequency

44.1/48/88.2/96 kHz

### Quantization bit rate

24-bit

---

## Inputs

---

---

### Analog inputs

---

#### Microphone inputs (MIC IN 1-6)

Balanced

Connectors: XLR-3-31 (1: GND, 2: HOT, 3: COLD)

Input impedance: 2.2 k $\Omega$

Nominal input level: -14 dBu (0.15 Vrms)

Minimum input level: -58 dBu (0.001 Vrms)

Maximum input level: +2 dBu (0.98 Vrms)

#### Line inputs (LINE IN 3-6)

Balanced

Connectors:

6.3-mm (1/4") TRS phone jacks (Tip: HOT, Ring: COLD, Sleeve: GND)

Input impedance: 15 k $\Omega$

Nominal input level: +4 dBu (1.23 Vrms)

Minimum input level: -40 dBu (0.008 Vrms)

Maximum input level: +20 dBu (7.75 Vrms)

#### Instrument inputs (INST IN 1-2)

Unbalanced

Connectors: 6.3-mm (1/4") TS phone jacks (Tip: HOT, Sleeve: GND)

Input impedance: 1 M $\Omega$

Nominal input level: -13 dBV (0.22 Vrms)

Minimum input level: -57 dBV (0.001 Vrms)

Maximum input level: +3 dBV (1.41 Vrms)

---

## Digital input

### Coaxial (DIGITAL IN)

Connector: RCA pin jack

Format: IEC 60958-3 (S/PDIF)

---

## Outputs

---

---

### Analog outputs

---

#### Line outputs (LINE OUT L-R)

Unbalanced

Connectors: RCA pin jacks

Output impedance: 200 $\Omega$

Nominal output level: -10 dBV (0.316 Vrms)

Maximum output level: +6 dBV (2 Vrms)

#### Headphones outputs (PHONES 1-2)

Connectors:

3.5-mm (1/8") stereo mini phone jack

6.3-mm (1/4") stereo phone jack

Maximum output: 49 mW + 49 mW (1 kHz, 0.1%, 32 $\Omega$ )

---

## Digital output

### Coaxial (DIGITAL OUT)

Connector: RCA pin jack

Format: IEC 60958-3 (S/PDIF)

---

## Control I/O

---

### MIDI input (MIDI IN)

Connector: 5-PIN DIN

Format: standard MIDI format

### MIDI output (MIDI OUT)

Connector: 5-PIN DIN

Format: standard MIDI format

### USB (USB)

Connector: 4-pin USB type B

Format: USB 2.0 HIGH SPEED (480 MHz)

---

## Audio performance

---

### Frequency response

20 Hz-20 kHz +0.5/-1.5 dB (44.1/48 kHz, JEITA)

20 Hz-40 kHz +0.5/-1.5 dB (88.2/96 kHz, JEITA)

### Signal-to-noise ratio

98 dB or higher (LINE IN to LINE OUT with Gain knobs at minimum, 44.1 kHz, JEITA)

### Total harmonic distortion

0.007% or less (LINE IN to LINE OUT with Gain knobs at minimum, JEITA)

---

## Computer requirements

---

See the TASCAM website for updated information about OS compatibility.

---

## Windows

### Supported Operating system

Windows XP 32 bit SP2 or later

Windows XP 64 bit SP2 or later

Windows Vista 32 bit SP2 or later

Windows Vista 64 bit SP2 or later

Windows 7 32 bit

Windows 7 64 bit

### Supported computer system

Windows compatible computer with a USB port (USB 2.0 is recommended)

CPU/clock:

Pentium 4 1.4 GHz or faster

AMD Athlon 1.4 GHz or faster (or equivalent processor)

Memory:

1 GB or more

---

## Macintosh

### Supported operating system:

Mac OS X 10.6.3 or later

### Supported computer system:

Apple Macintosh series equipped with a USB port as standard equipment

CPU/clock:

Intel processor

Memory:

1 GB or more

---

## General

---

### Power

TASCAM PS-P520 AC adaptor (included)

AC input: 100-240 V, 1.0 A

DC output: +5 V, 2.0 A

### Power consumption

9.0 W

### External dimensions (W x H x D)

262 x 41 x 152 mm (without projections)

262 x 44 x 165 mm (with projections)

### Weight

800 g

### Operating temperature range

5-35° C

# 11 – Specifications

## Dimensional drawing

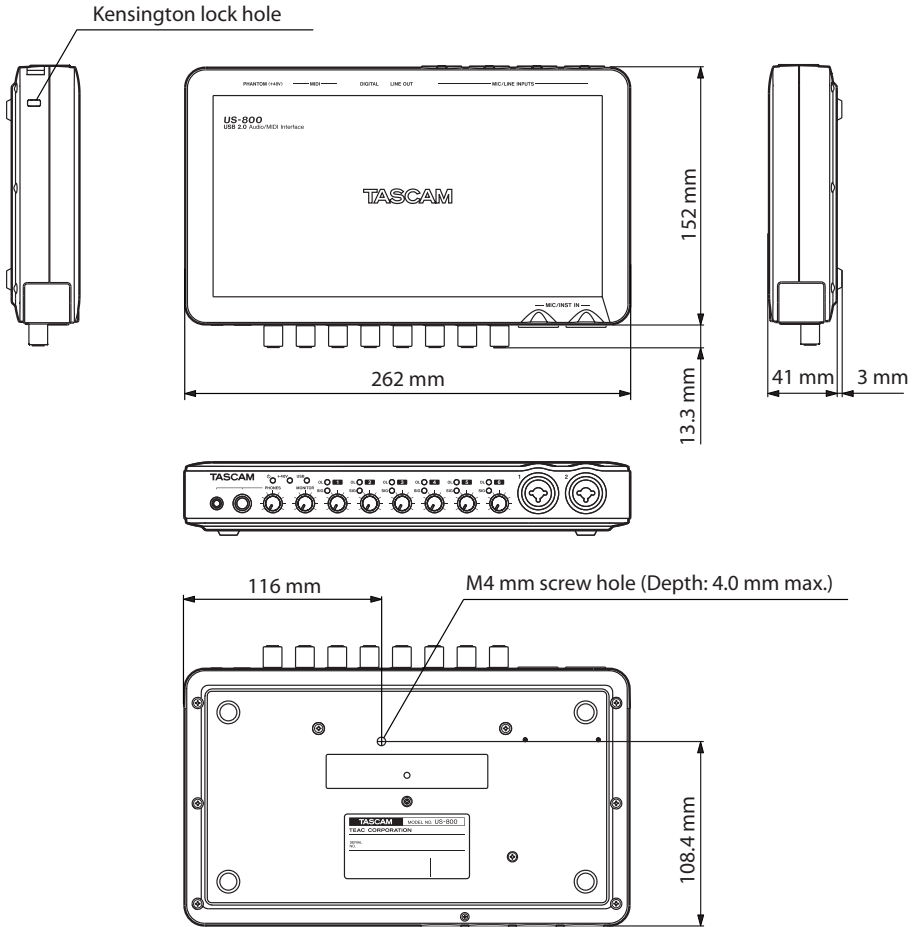

- Illustrations in this manual may differ in part from the actual product.
- Specifications and the external appearance may be changed without notification to improve the product.

## Block diagram

US-800 Audio Flow Diagram

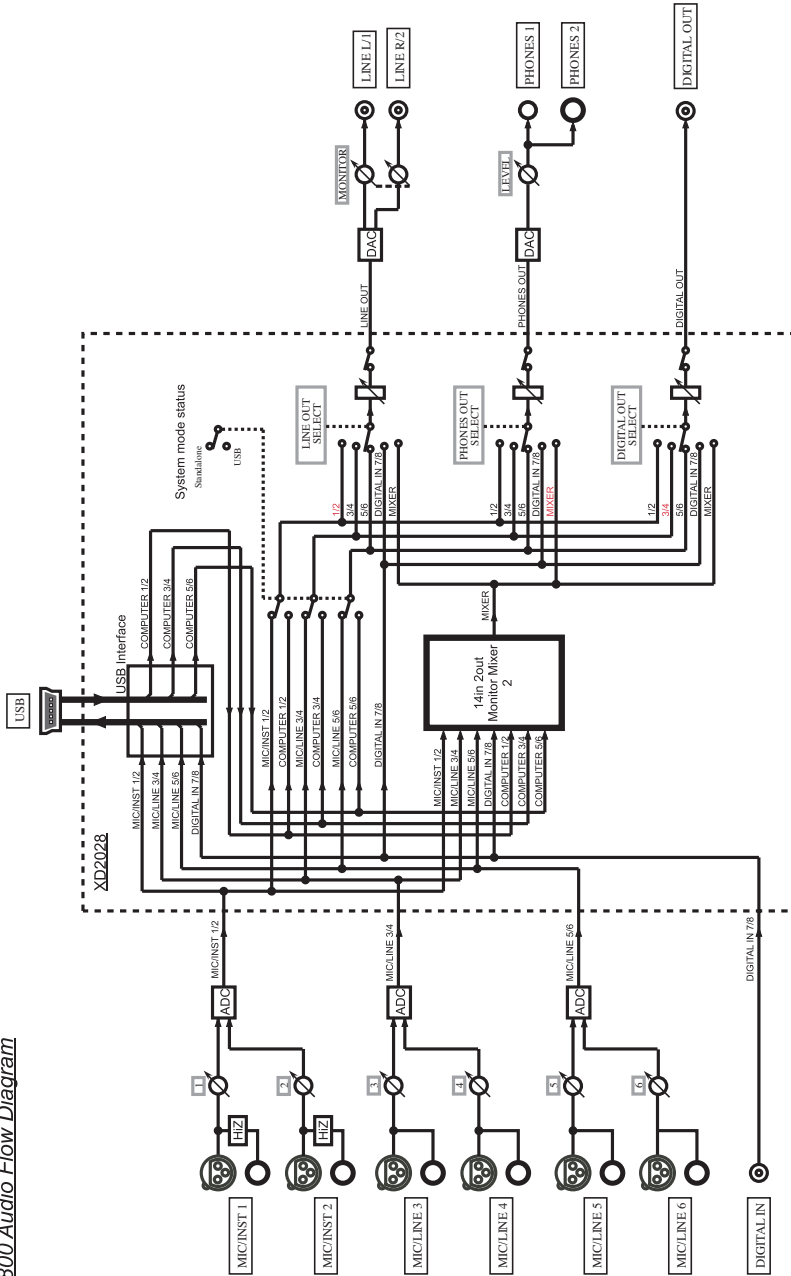





**TASCAM**  
TEAC PROFESSIONAL

# US-800

**TEAC CORPORATION**

Phone: +81-42-356-9143  
1-47 Ochiai, Tama-shi, Tokyo 206-8530 Japan

[www.tascam.jp](http://www.tascam.jp)

**TEAC AMERICA, INC.**

Phone: +1-323-726-0303  
7733 Telegraph Road, Montebello, California 90640 USA

[www.tascam.com](http://www.tascam.com)

**TEAC CANADA LTD.**

Phone: +1905-890-8008 Facsimile: +1905-890-9888  
5939 Wallace Street, Mississauga, Ontario L4Z 1Z8, Canada

[www.tascam.com](http://www.tascam.com)

**TEAC MEXICO, S.A. de C.V.**

Phone: +52-55-5010-6000  
Río Churubusco 364, Colonia Del Carmen, Delegación Coyoacán, CP 04100, México DF, México

[www.teacmexico.net](http://www.teacmexico.net)

**TEAC UK LIMITED**

Phone: +44-8451-302511  
Suites 19 & 20, Building 6, Croxley Green Business Park, Hatters Lane, Watford, Hertfordshire. WD18 8TE, U.K.

[www.tascam.co.uk](http://www.tascam.co.uk)

**TEAC EUROPE GmbH**

Phone: +49-611-71580  
Bahnstrasse 12, 65205 Wiesbaden-Erbenheim, Germany

[www.tascam.de](http://www.tascam.de)